

シャープ製LED照明器具 配光データシート 形名 DL-AA02NM

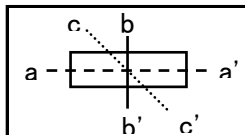
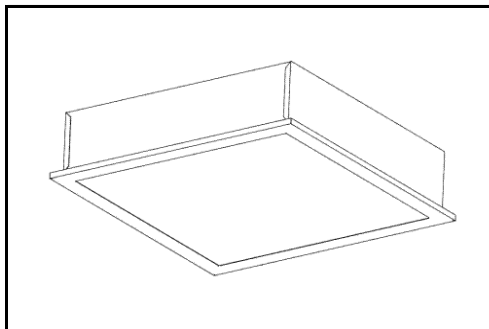

器具光束	9,600 lm
上方光束	0 lm
下方光束	9,600 lm
最大光度	3,335 cd

初期値

光源	LED
形式	スクエア型(天井埋込型)
パネル	乳白パネル
色温度	5000K
保守率	良:0.93 中:0.9 否:0.86
最大取付間隔	a-a 1.3H b-b 1.3H
備考	

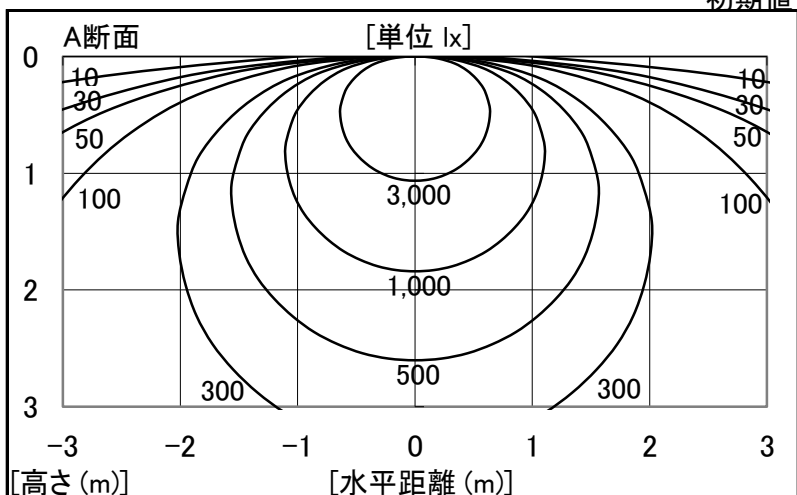

角度	光度[cd/1,000lm]		
	A-A'	B-B'	C-C'
0	347	347	-
10	342	342	-
20	324	324	-
30	295	295	-
40	258	258	-
50	211	211	-
60	156	156	-
70	94	94	-
80	36	36	-
90	1	1	-
100	0	0	-
110	0	0	-
120	0	0	-
130	0	0	-
140	0	0	-
150	0	0	-
160	0	0	-
170	0	0	-
180	0	0	-

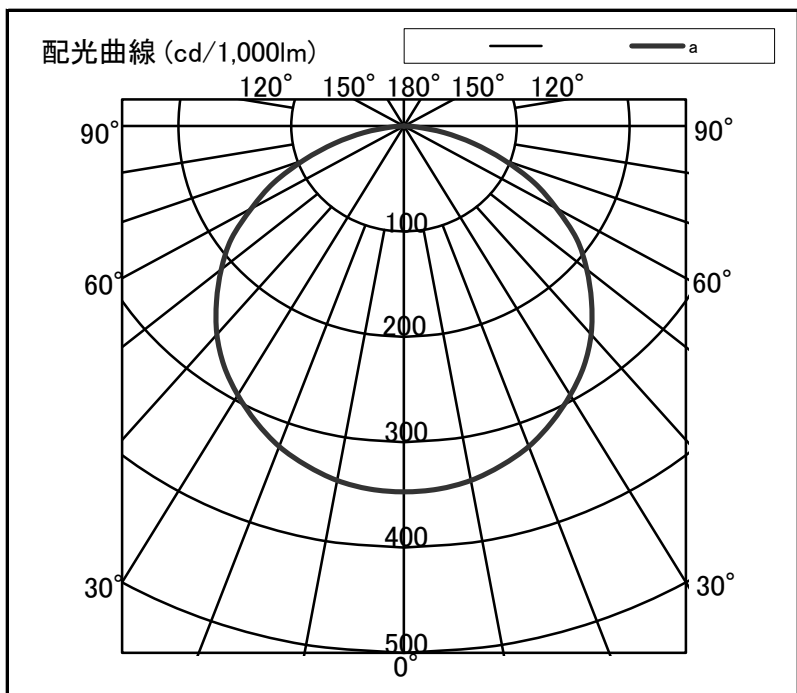

反射率	天井		80		70		50		30		20		0							
	壁	床	70	50	30	70	50	30	50	30	30	10	0							
室指数	照明率(×0.01)																			
0.6	62	58	48	45	39	38	61	56	47	45	38	37	46	44	38	37	37	37	32	30
0.8	75	68	60	56	51	49	72	66	59	56	50	48	57	54	49	48	48	47	42	40
1.0	83	74	69	64	59	56	80	73	67	63	59	56	65	61	57	55	56	54	50	48
1.25	91	80	77	71	68	64	88	79	76	70	67	63	72	68	65	62	63	61	57	55
1.5	96	85	84	76	75	69	93	83	82	75	73	69	78	73	71	68	69	67	62	60
2.0	104	90	93	83	85	77	100	89	91	82	83	77	86	80	80	75	77	74	70	68
2.5	109	94	99	88	92	83	105	92	96	87	90	82	91	84	86	80	82	79	75	73
3.0	112	96	104	91	97	86	108	95	101	90	95	85	95	88	90	84	86	82	79	77
4.0	117	99	110	95	104	91	112	98	106	94	101	90	100	92	96	89	91	87	84	82
5.0	119	101	114	98	109	94	115	100	110	96	106	94	103	94	100	92	95	90	87	85
7.0	123	103	118	101	114	98	118	102	114	99	111	97	107	97	104	95	99	93	91	89
10	125	105	122	103	119	101	121	103	118	102	115	100	110	99	108	98	102	96	94	92