

シャープ製LED照明器具 配光データシート 形名 DL-D057N

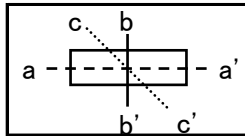
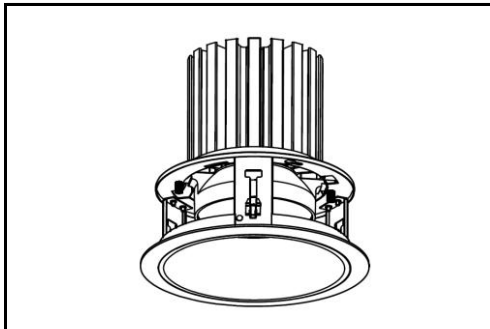

器具光束	9,500 lm
上方光束	0 lm
下方光束	9,500 lm
最大光度	10,740 cd

初期値

光源	LED
形式	ダウンライト
埋込穴径	Φ200
色温度	5000K
保守率	良:0.76 中:0.72 否:0.64
最大取付間隔	a-a 1.2H
備考	

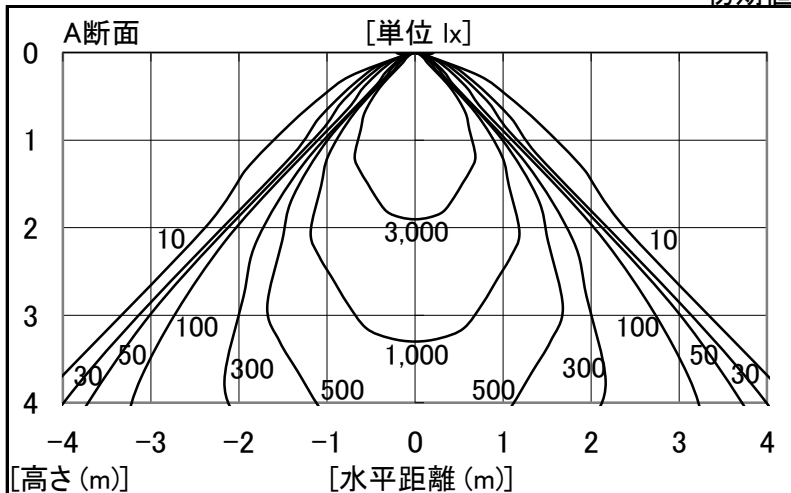

角度	光度[cd/1,000lm]		
	A-A'	B-B'	C-C'
0	1130	-	-
10	1060	-	-
20	782	-	-
30	584	-	-
40	242	-	-
50	10	-	-
60	2	-	-
70	0	-	-
80	0	-	-
90	0	-	-
100	0	-	-
110	0	-	-
120	0	-	-
130	0	-	-
140	0	-	-
150	0	-	-
160	0	-	-
170	0	-	-
180	0	-	-

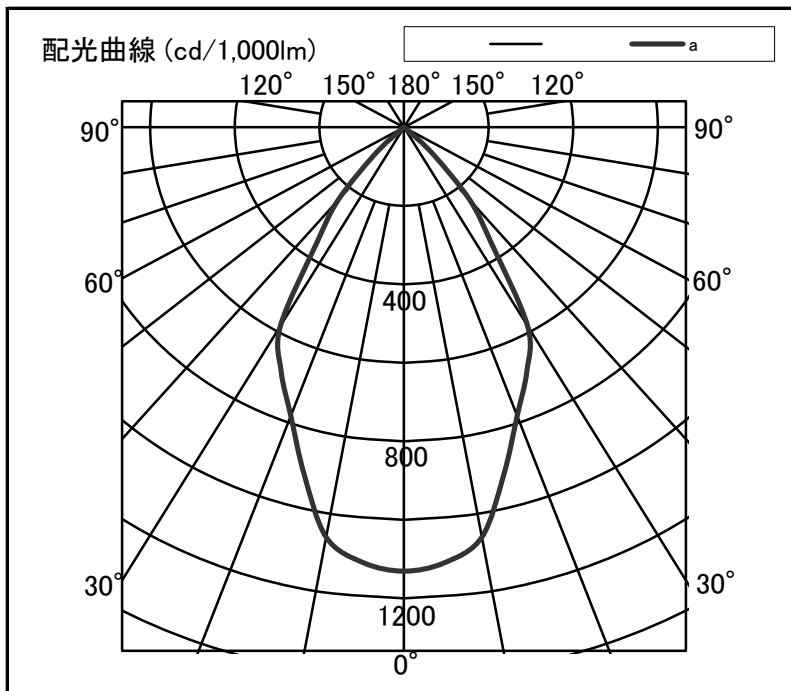

反射率	天井		80		70		50		30		20		0							
	壁	床	70	50	30	70	50	30	50	30	30	10	0							
室指数	照明率(×0.01)																			
0.6	91	84	82	78	76	74	90	83	81	77	76	74	80	77	75	73	74	73	71	70
0.8	99	90	91	85	85	81	98	90	90	85	84	81	88	84	83	81	82	80	78	77
1.0	105	94	97	90	91	86	103	93	95	89	90	86	93	88	88	85	87	85	83	82
1.25	110	97	102	93	96	90	107	96	100	93	95	90	97	92	93	89	91	88	86	85
1.5	113	99	105	96	100	93	110	98	104	95	99	92	100	94	96	91	94	91	89	88
2.0	117	102	111	99	106	96	114	101	108	98	104	96	104	97	100	95	97	94	92	91
2.5	120	103	114	101	110	99	116	102	111	100	107	98	106	98	103	97	100	96	94	92
3.0	121	104	117	102	112	100	118	103	114	101	110	99	108	99	105	98	101	97	95	94
4.0	124	105	120	104	116	102	120	104	116	103	113	101	110	101	108	100	103	98	97	95
5.0	125	106	122	105	119	103	121	105	118	104	116	103	112	102	110	101	104	99	98	96
7.0	127	107	124	106	122	105	123	106	120	105	118	104	113	103	112	102	106	100	99	97
10	128	107	126	107	125	106	124	106	122	106	121	105	115	104	113	103	107	101	100	98