

シャープ製LED照明器具 配光データシート 形名 DL-D056N

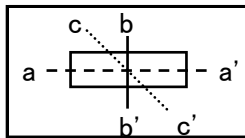
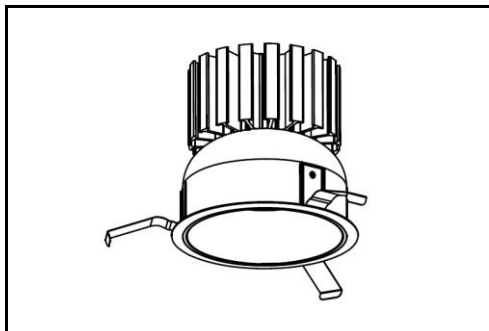

器具光束	7,310 lm
上方光束	0 lm
下方光束	7,310 lm
最大光度	7,870 cd

初期値

光源	LED
形式	ダウンライト
埋込穴径	Φ150
色温度	5000K
保守率	良:0.76 中:0.72 否:0.64
最大取付間隔	a-a 1.3H
備考	

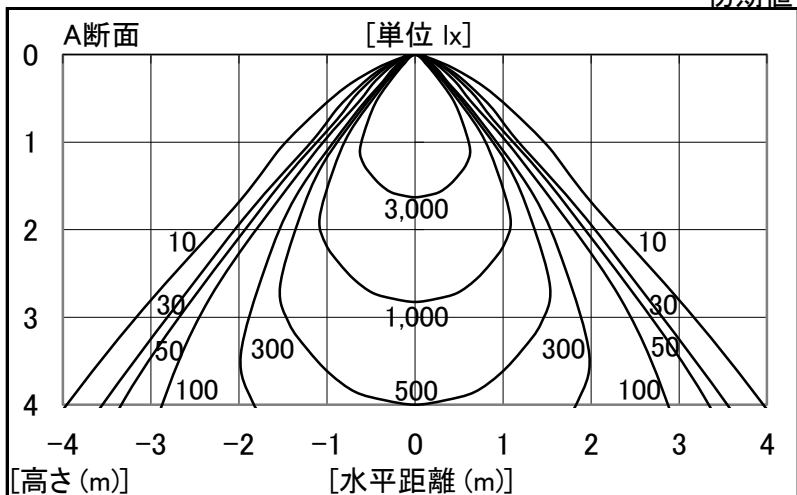

角度	光度[cd/1,000lm]		
	A-A'	B-B'	C-C'
0	1077	-	-
10	1031	-	-
20	863	-	-
30	634	-	-
40	176	-	-
50	8	-	-
60	1	-	-
70	0	-	-
80	0	-	-
90	0	-	-
100	0	-	-
110	0	-	-
120	0	-	-
130	0	-	-
140	0	-	-
150	0	-	-
160	0	-	-
170	0	-	-
180	0	-	-

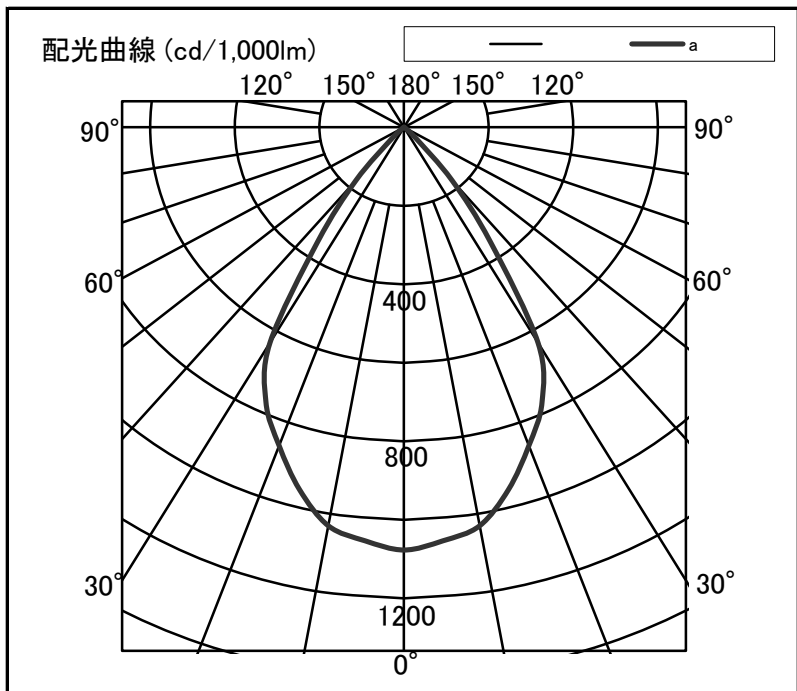

反射率	天井		80		70		50		30		20		0							
	壁	床	70	50	30	70	50	30	50	30	30	10	0							
室指数	照明率(×0.01)																			
0.6	94	86	85	81	79	77	92	86	84	80	79	77	83	80	78	77	78	76	74	73
0.8	101	92	93	87	87	84	100	91	92	87	87	84	90	86	86	83	85	83	81	80
1.0	106	96	98	91	93	88	104	95	97	91	92	88	95	90	91	87	89	87	85	84
1.25	111	98	103	95	98	92	108	98	102	94	97	91	99	93	95	91	93	90	88	87
1.5	114	100	107	97	102	94	111	99	105	96	100	94	101	95	98	93	95	92	90	89
2.0	118	102	112	100	107	97	115	101	109	99	105	97	105	98	102	96	98	95	93	92
2.5	120	104	115	101	111	99	117	103	112	101	108	99	107	99	104	98	100	96	95	93
3.0	122	105	117	103	113	101	118	103	114	102	111	100	109	100	106	99	102	97	96	95
4.0	124	106	120	104	117	103	120	105	117	103	114	102	111	101	109	100	104	99	97	96
5.0	126	106	122	105	119	104	121	105	119	104	116	103	112	102	110	101	105	100	98	97
7.0	127	107	125	106	122	105	123	106	121	105	119	104	114	103	112	102	106	101	99	98
10	128	107	127	107	125	106	124	106	122	106	121	105	115	104	114	103	107	101	100	98