

シャープ製LED照明器具 配光データシート 形名 DL-D1503N

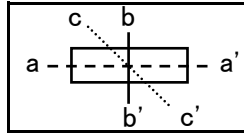

器具光束	1,470 lm
上方光束	0 lm
下方光束	1,470 lm
最大光度	759 cd
初期値	

光源	LED
形式	ダウンライト
パネル	半透明パネル
色温度	昼白色相当
保守率	0.7
最大取付間隔	a-a 1.2H b-b 1.2H
備考	

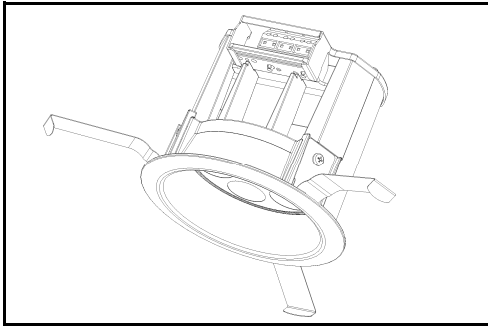
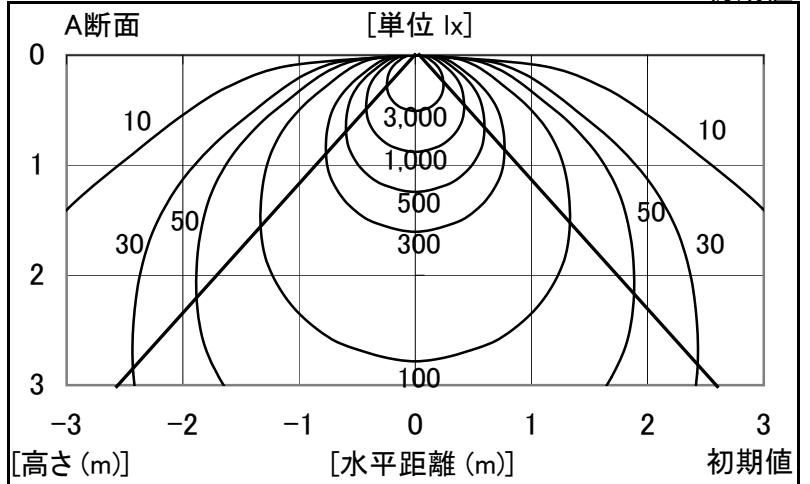

角度	光度[cd/1,000lm]		
	A-A'	B-B'	C-C'
0	516	-	-
10	495	-	-
20	453	-	-
30	380	-	-
40	283	-	-
50	189	-	-
60	107	-	-
70	40	-	-
80	14	-	-
90	0	-	-
100	0	-	-
110	0	-	-
120	0	-	-
130	0	-	-
140	0	-	-
150	0	-	-
160	0	-	-
170	0	-	-
180	0	-	-

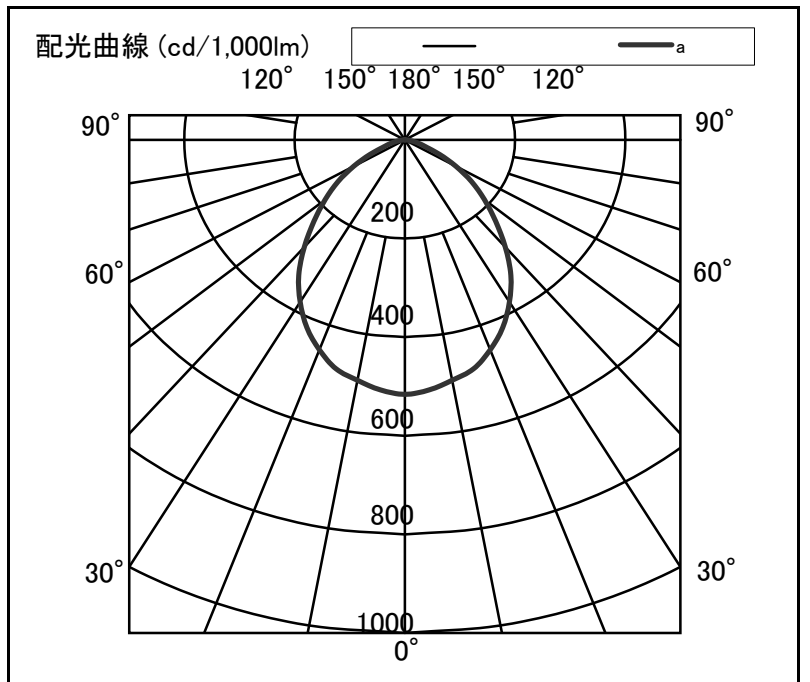

反射率	天井	80						70						50				30		20		0	
		壁		50		30		70		50		30		50		30		30		10		0	
	床	30	10	30	10	30	10	30	10	30	10	30	10	30	10	30	10	30	10	10	0	10	0
室指数		照明率(×0.01)																					
0.6	70	65	57	54	49	47	69	64	56	54	49	47	55	53	48	47	47	46	42	41			
0.8	82	75	69	65	61	59	80	73	68	64	60	58	66	63	59	58	58	57	53	51			
1.0	90	81	78	72	70	66	88	80	77	72	69	66	74	70	67	65	66	64	60	59			
1.25	97	86	86	79	78	73	94	85	84	78	77	72	81	76	75	72	73	71	67	65			
1.5	102	90	92	83	84	78	99	88	90	82	82	77	86	80	80	76	78	75	72	70			
2.0	109	94	100	89	93	84	105	93	97	88	91	84	93	86	87	82	84	81	78	76			
2.5	113	97	105	93	99	89	109	96	102	92	96	88	97	90	92	87	89	85	82	81			
3.0	116	99	109	95	103	92	112	98	106	94	100	91	100	92	96	89	92	88	85	83			
4.0	119	102	114	98	109	96	115	100	110	97	106	95	104	95	101	93	96	91	89	87			
5.0	122	103	117	100	113	98	117	102	113	99	110	97	107	97	104	95	99	94	92	90			
7.0	124	105	121	103	117	101	120	103	117	102	114	100	110	99	107	98	102	96	94	92			
10	126	106	124	104	121	103	122	105	120	103	117	102	112	101	110	100	104	98	97	95			