

シャープ製LED照明器具 配光データシート 形名 DL-D1009N

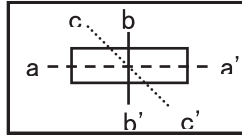

器具光束	1,260 lm
上方光束	0 lm
下方光束	1,260 lm
最大光度	998 cd
初期値	

光源	LED
形式	ダウンライト
パネル	半透明パネル
色温度	昼白色相当
保守率	良:0.88 中:0.86 否:0.81
最大取付間隔	a-a 1.2H b-b 1.2H
備考	

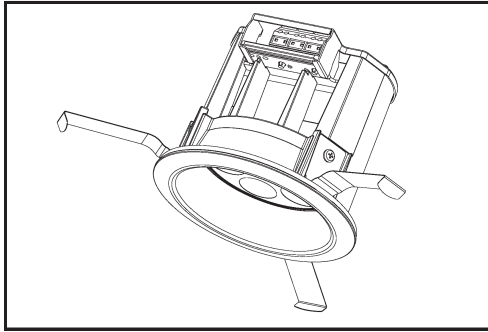
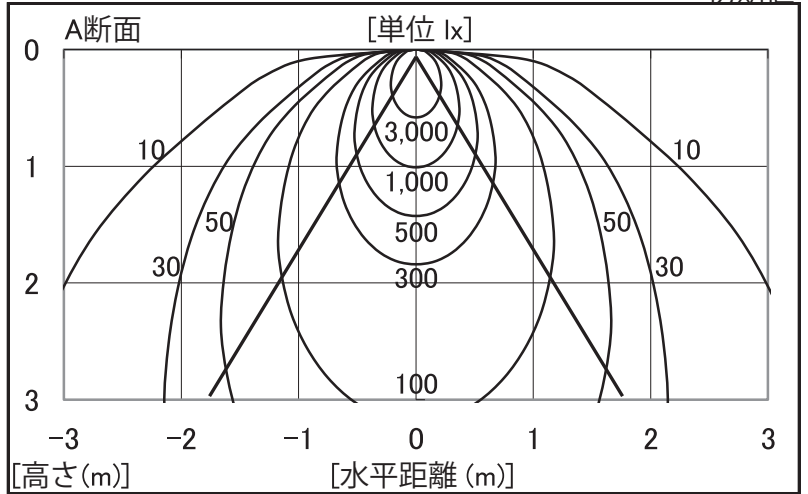

角度	光度[cd/1,000lm]		
	A-A'	B-B'	C-C'
0	792	-	-
10	730	-	-
20	576	-	-
30	403	-	-
40	250	-	-
50	144	-	-
60	75	-	-
70	29	-	-
80	11	-	-
90	0	-	-
100	0	-	-
110	0	-	-
120	0	-	-
130	0	-	-
140	0	-	-
150	0	-	-
160	0	-	-
170	0	-	-
180	0	-	-

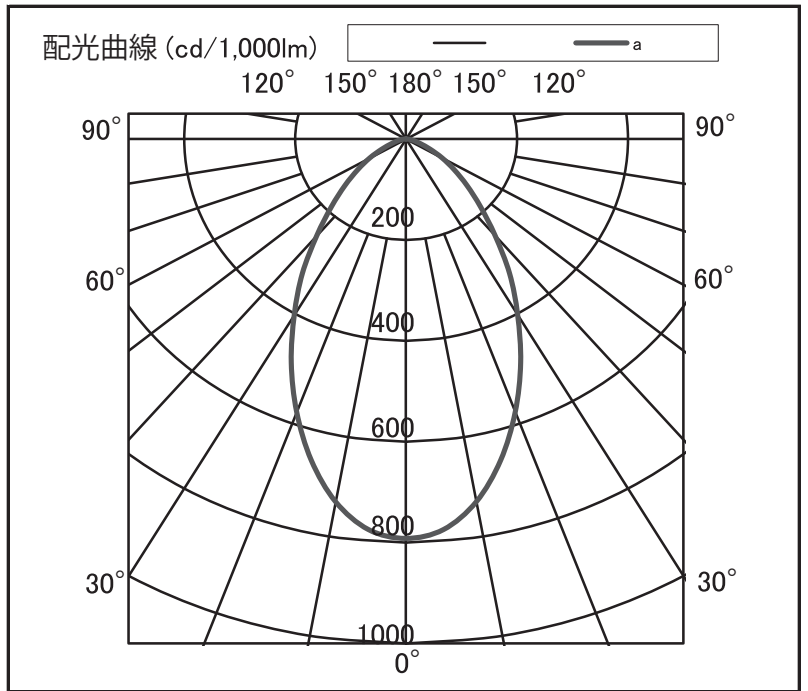

反射率	天井		80		70		50		30		20		0							
	壁	床	70	50	30	70	50	30	50	30	30	10	0							
室指数	照明率(×0.01)																			
0.6	77	71	66	62	58	57	76	70	65	62	58	56	64	61	57	56	57	56	52	51
0.8	88	80	77	72	69	66	86	79	76	71	69	66	74	70	67	66	66	65	62	60
1.0	95	86	84	78	77	73	93	84	83	78	76	73	80	76	74	72	73	71	68	66
1.25	101	90	91	84	84	79	99	89	90	83	83	78	86	81	81	77	79	77	73	72
1.5	106	93	96	87	89	83	103	92	94	86	88	82	91	85	85	81	83	80	77	76
2.0	111	97	103	92	97	88	108	96	101	91	95	88	96	90	92	87	89	85	83	81
2.5	115	99	108	95	102	92	112	98	105	94	100	91	100	93	96	90	92	89	86	84
3.0	118	101	111	98	106	95	114	100	108	97	104	94	103	95	99	92	95	91	89	87
4.0	121	103	116	100	111	98	117	102	112	99	109	97	106	97	103	95	98	94	92	90
5.0	123	104	119	102	115	100	119	103	115	101	112	99	108	99	106	97	101	96	94	92
7.0	125	105	122	104	119	102	121	104	118	103	116	101	111	101	109	100	103	98	96	94
10	127	107	125	105	123	104	123	105	121	104	119	103	113	102	111	101	105	99	98	96