

シャープ製LED照明器具 配光データシート 形名 DL-D024L

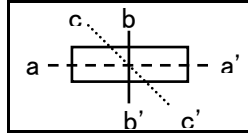
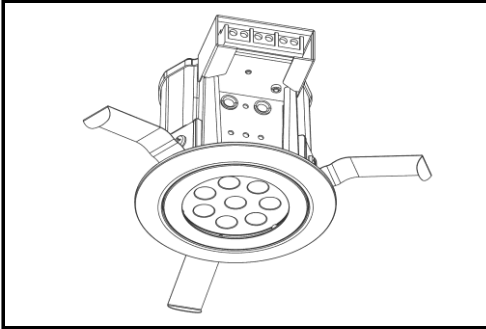

器具光束	480 lm
上方光束	0 lm
下方光束	480 lm
最大光度	280 cd

初期値

光源	LED
形式	ダウンライト
パネル	透明パネル
色温度	2,900K
保守率	良:0.69 中:0.67 否:0.63
最大取付間隔	a-a 1.3H b-b 1.3H
備考	

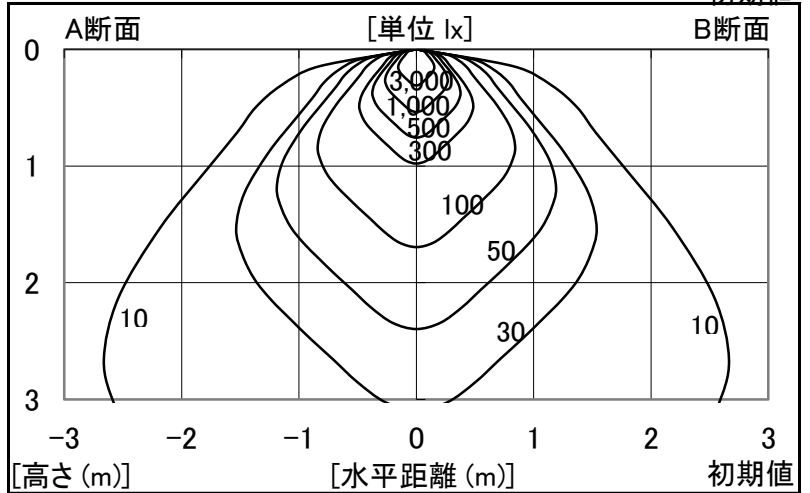

角度	光度[cd/1,000lm]		
	A-A'	B-B'	C-C'
0	582	-	-
10	510	-	-
20	422	-	-
30	371	-	-
40	320	-	-
50	218	-	-
60	80	-	-
70	36	-	-
80	7	-	-
90	0	-	-
100	0	-	-
110	0	-	-
120	0	-	-
130	0	-	-
140	0	-	-
150	0	-	-
160	0	-	-
170	0	-	-
180	0	-	-

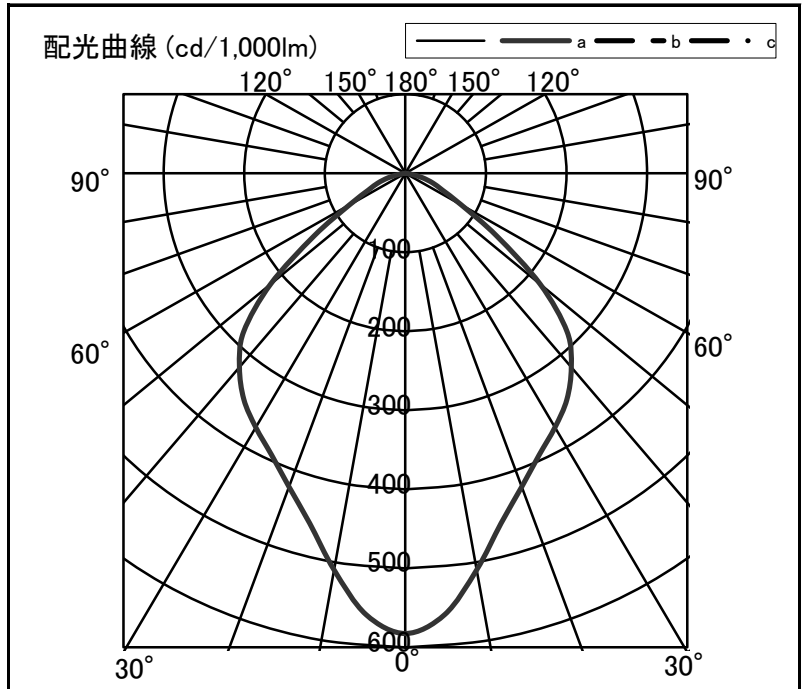

反射率	天井						70						50						30		20		0	
	壁		70		50		30		70		50		30		50		30		30		10		0	
床	30	10	30	10	30	10	30	10	30	10	30	10	30	10	30	10	30	10	30	10	10	0	10	0
室指数	照明率(×0.01)																							
0.6	69	64	56	53	47	46	67	63	55	52	47	46	53	51	46	45	46	45	41	39				
0.8	82	74	69	64	60	58	80	73	68	64	60	58	66	63	59	57	58	56	52	51				
1.0	90	81	78	72	69	66	87	79	76	71	69	65	74	70	67	65	66	64	60	58				
1.25	97	86	86	79	78	73	94	85	84	78	77	72	81	76	75	71	73	71	67	65				
1.5	102	90	91	83	84	78	99	88	89	82	82	77	86	80	80	76	78	75	72	70				
2.0	109	95	100	89	93	84	105	93	97	88	91	84	93	86	87	82	84	81	78	76				
2.5	113	97	105	93	99	92	109	96	102	92	96	88	97	90	93	87	89	85	82	81				
3.0	116	99	109	95	103	92	112	98	106	94	101	91	100	92	96	90	92	88	85	84				
4.0	120	102	114	99	109	96	116	100	111	98	106	95	104	95	101	93	96	92	89	88				
5.0	122	103	117	101	113	98	118	102	114	100	110	97	107	97	104	96	99	94	92	90				
7.0	125	105	121	103	118	103	120	104	117	102	114	100	110	100	108	98	102	96	95	93				
10	127	106	124	105	122	101	122	105	120	104	118	102	112	101	111	100	104	98	97	95				